



"Smart" Quest Single Reflection ATR Accessory for Shimadzu Instruments

User Manual



2I-10850-3

“Smart” Quest Single Reflection ATR Accessory for Shimadzu Instruments

User Manual

“Smart” Quest Single Reflection ATR Accessory for Shimadzu Instruments P/N GS10850 Series

CONTENTS

1. INTRODUCTION	3
2. SAFETY CONSIDERATIONS	5
3. CHECKLIST OF CONTENTS.....	6
4. FITTING OF THE COVER PLATE GS10854 INTO SHIMADZU SPECTROMETERS.....	7
5. INSTALLATION USING BENCHMARK™ BASEPLATE FOR SHIMADZU SPECTROMETERS (P/N 549-456).....	9
PROCEDURE FOR INSTALLATION.....	10
FIXING THE QUEST OPTICAL UNIT TO THE BENCHMARK™ BASEPLATE	11
INSTALLING THE QUEST OPTICAL UNIT AND BENCHMARK™ BASEPLATE ASSEMBLY INTO THE SPECTROMETER SAMPLE COMPARTMENT	13
USE OF THE SHORTENED PURGE BELLOWS P/N GS10855	14
ALIGNMENT PROCEDURE.....	15
6. SMART QUEST ATR ACCESSORY PART IDENTIFICATION LIST.....	16
7. SMART QUEST ATR ACCESSORY SPARE PARTS	17
8. SMART QUEST ATR ACCESSORY SERIAL NUMBERS	18

© April 2016 Specac Ltd. All rights reserved.
Benchmark and Brilliant Spectroscopy are trademarks of Specac Ltd.
Other product names mentioned herein may be trademarks
of their respective owners.

1. Introduction

Thank you for buying a Specac product. We trust it will provide you with invaluable and excellent service in use.

The “Smart” Quest Single Reflection ATR Accessory for Shimadzu Instruments as the P/N GS10850 Series is a variant of the Quest ATR Accessory (P/N GS10800 Series) that has been specifically designed for installation and use in a Shimadzu IR-Affinity or Tracer 100 IR spectrometer system.

There are twelve different configurations of Quest ATR Accessory under the P/N GS10850 Series consisting of a choice of four different ATR crystal puck options supplied on 3 different coloured optical units. They are provided under the following part numbers:-

GS10850-A - Quest ATR Diamond Accessory (Aqua)
GS10850-B - Quest ATR Diamond Accessory (Black)
GS10850-R - Quest ATR Diamond Accessory (Red)
GS10851-A - Quest ATR Diamond Accessory extended range (Aqua)
GS10851-B - Quest ATR Diamond Accessory extended range (Black)
GS10851-R - Quest ATR Diamond Accessory extended range (Red)
GS10852-A - Quest ATR ZnSe Accessory (Aqua)
GS10852-B - Quest ATR ZnSe Accessory (Black)
GS10852-R - Quest ATR ZnSe Accessory (Red)
GS10853-A - Quest ATR Germanium Accessory (Aqua)
GS10853-B - Quest ATR Germanium Accessory (Black)
GS10853-R - Quest ATR Germanium Accessory (Red)

The Benchmark™ baseplate (P/N 549-456) supplied with each of the above part numbered complete Accessory options, onto which the Quest ATR accessory is mounted for installation, is fitted with an integrated circuit “chip” that has been programmed for the IR spectrometer to recognise that the Quest ATR Accessory has been installed for use. When the Benchmark™ baseplate itself is installed into the spectrometer sample compartment, recognition is established.

User Manual

The Benchmark™ baseplate supplied (P/N 549-456) has also been specifically designed to securely attach the Quest ATR Accessory from use of dual front and rear screw fixings. The standard thumbscrew fixing at the front of the Quest optical unit is used as normal, but there is an additional slot screw fixing that passes through the rear support pillar of the Benchmark™ baseplate to locate into the underside of the optical unit.

Additional special parts supplied with the Smart Quest ATR Accessory for Shimadzu spectrometers include a cover plate (P/N GS10854) and a pair of shortened purge bellows (P/N GS10855). The cover plate is used to seal over the gap exposed between the optical bench internal componentry and the top, rear lip edges of the standard sample compartment when the standard sample compartment lid has been removed to prevent any potential ingress of dirt/dust etc into the optical bench of the spectrometer itself. The purge bellows are shorter than the standard pair of purge bellows (P/N GS10707) normally supplied with the Quest ATR Accessory, to fit neatly and exactly between the Quest optical unit aperture ports and the sample compartment inlet and outlet optical beam side ports for both the IR-Affinity and Tracer 100 instruments.

This User Instruction Manual for the GS10850 Series of Quest ATR Accessory for Shimadzu Instruments is to be used in conjunction with the standard Quest ATR Accessory User Instruction Manual, also supplied. Descriptions for the Benchmark™ baseplate (P/N 549-456) attachment to the Quest optical unit and installation, and fitting of the cover plate (P/N GS10854) are to be followed from this current User Instruction Manual 2I-10850-2. A subsequent alignment procedure and the actual sampling usage of the Quest ATR Accessory are to be followed from the current User Instruction Manual 2I-10800-4.

2. Safety Considerations

With use of any spectroscopic accessory that involves the study of a wide range of chemical samples, the associated risk in handling may mostly be attributed to the specific sample type to be handled itself. As far as it possible you should follow a procedure for safe handling and containment of the type of sample to be used.

With respect to safety of use specifically to the Quest ATR Accessory, this uses different crystal materials for the ATR crystal puck assemblies where a sample is brought into contact for analytical spectroscopic study. As standard, Diamond (type IIIA), Germanium (Ge) and Zinc Selenide (ZnSe) are the three crystal materials of choice that can be used.



Caution: *Out of these three different crystal types, ZnSe is the most potentially hazardous material with respect to toxicity risk in use and handling.*

Both diamond and Ge crystal materials can be considered relatively safe to use, although germanium may be harmful to the body if it is ingested in significant quantity. The general rule when working with **any** crystal material (and sample) **is to always wear gloves and safety gear** (e.g. safety spectacles) when handling to obviate the risk of contact with the skin.

Provided with each crystal version of puck assembly is a window material safety data sheet for the crystal material itself that can be consulted for safe handling. A copy of each of these datasheets can also be found in the Quest User Instruction Manual 2I-10800-4 in the **Notes On Cleaning** Section found on pages 37, 38 and 39.

3. Checklist of Contents

The “Smart” Quest ATR Accessory for Shimadzu Instruments is provided in its own specific packaging.

Depending on which Quest ATR system (colour of optical unit and particular crystal puck assembly) has been ordered will determine the items to check on delivery.

Please check for the following.

- 1 Quest ATR Accessory (GS10850 Series) including optical unit (with top surface colour of choice) and clamp arm and anvil assembly.
- 1 Stainless steel flat anvil P/N GS10820.
- 1 Stainless steel pellet anvil P/N GS10821.
- 1 Volatiles cover P/N GS10825.
- 1 Cover plate for Shimadzu spectrometers P/N GS10854.
- 1 Pair of shortened purge bellows P/N GS10855.
- 1 ATR crystal puck assembly (choice of Diamond, ZnSe or Ge crystal puck assembly).

Any additional Quest ATR crystal pucks ordered with the accessory.

- 1 Ball driver 3.0mm (for optical unit cover plate removal).
- 1 Ball driver 2.5mm (for mirror adjustment in optical unit).
- 1 Benchmark™ baseplate P/N 549-456 for a Shimadzu IR-Affinity and Tracer 100 FTIR spectrometer.
- 1 Instruction manual 2I-10850-1 for Smart Quest ATR Accessory
- 1 Instruction manual 2I-10800-3 for Quest ATR Accessory.
- 1 Quickstart guide QS-10800-3 for Quest ATR Accessory.

Carefully remove your Quest ATR Accessory and ATR crystal puck assembly(ies) from the packaging in readiness for use.

4. Fitting of the Cover Plate P/N GS10854 Into Shimadzu Spectrometers

The cover plate P/N GS10854 supplied is shown as **Fig 1**. It is used to seal over the gap exposed between the optical bench internal componentry and the top, rear lip edges of the standard sample compartment when the standard sample compartment lid has been removed to prevent any potential ingress of dirt/dust etc into the optical bench of the spectrometer itself.

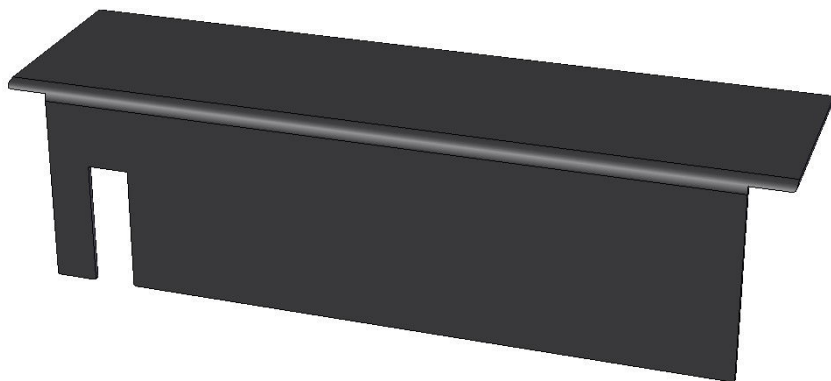

Fig 1. Cover Plate P/N GS10854

Magnetic strips attached to the underside of the cover plate are used to affix the cover plate into position within the sample compartment area.

To fit the cover plate P/N GS10854 correctly into position the standard sample compartment lid must be removed from the spectrometer. (Please refer to the user instructions supplied with the Shimadzu IR-Affinity and/or Tracer 100 instrument for advice on how this procedure is carried out).

When the sample compartment lid has been removed the cover plate P/N GS10854 is positioned as shown in **Fig 2**.

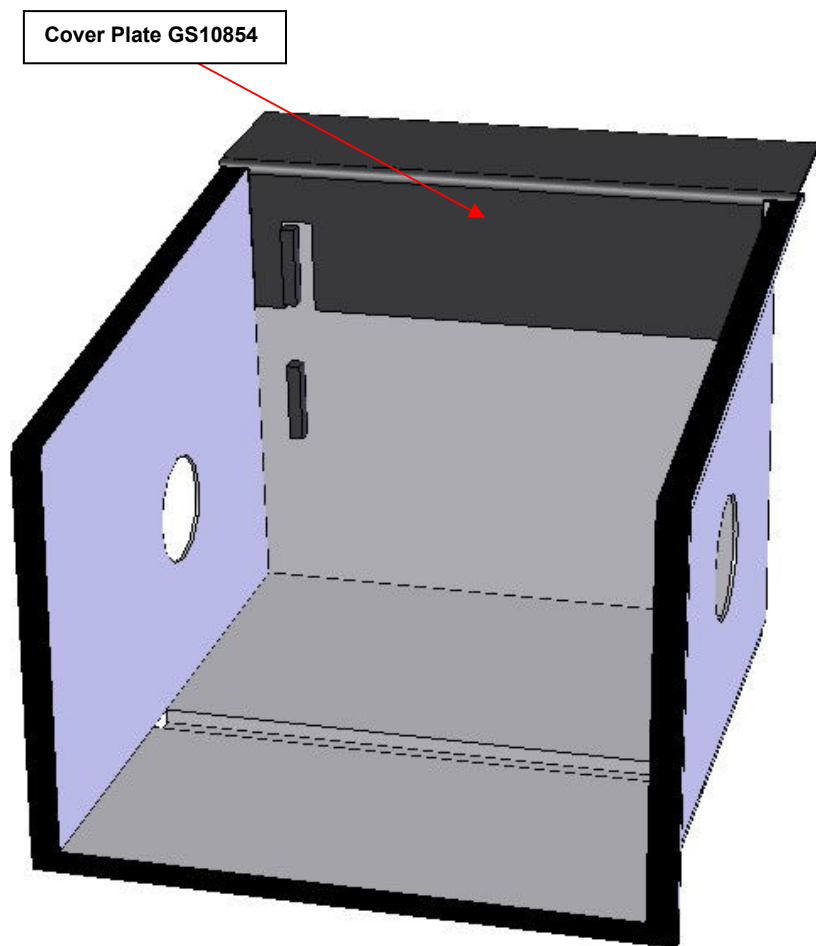

Fig 2. Cover Plate GS10584 as Positioned Correctly in the Sample Compartment Area of the Shimadzu Spectrometer

5. Installation Using Benchmark™ Baseplate for Shimadzu Spectrometers (P/N 549-456)

The Benchmark™ baseplate P/N 549-456 supplied for installation of the Quest ATR Accessory into the sample compartment of a Shimadzu IR-Affinity and/or Tracer 100 spectrometer system is shown in **Fig 3**. Both the upper and underside surfaces are shown.

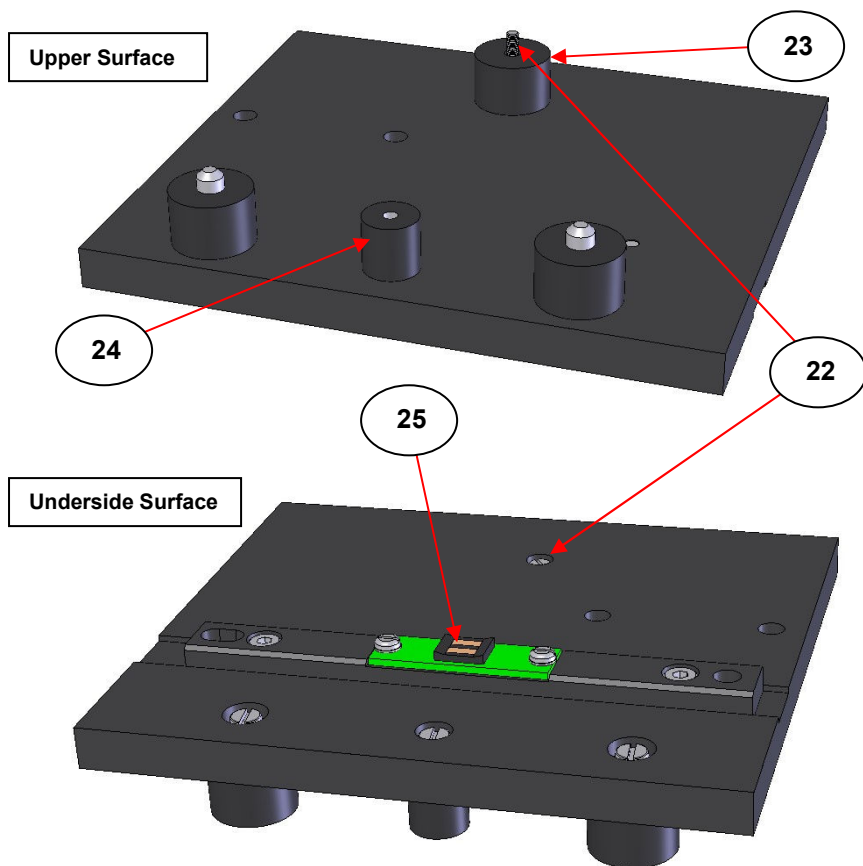

Fig 3. Benchmark Baseplate P/N 549-456

The upper surface of the Benchmark™ baseplate P/N 549-456 shows the arrangement of fixing pillars and location pins for attachment to the underside of the optical unit of the Quest ATR Accessory. An M3 x 25mm slot head fixing screw (22) passes centrally through the rear support pillar (23) for fixing into a corresponding screw location hole on the underside of the optical unit of the Quest ATR Accessory. The standard thumbscrew fixing (1) (see Fig 4), at the front of the optical unit of the Quest ATR accessory is used to affix to the central front pillar (24) of the Benchmark™ baseplate.

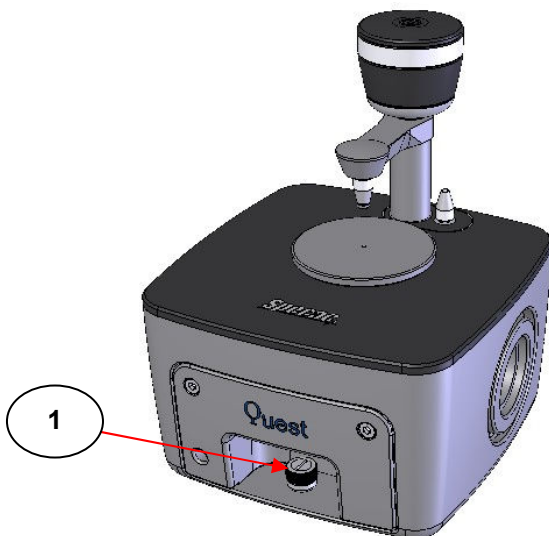

Fig 4. Quest ATR Accessory – Central Fixing Front Thumbscrew

Procedure for Installation

The Quest ATR Accessory is supported on a Benchmark™ baseplate when installed into a spectrometer. The Benchmark™ baseplate for its upper surface typically has three support pillars (one flat support pillar towards the rear (23) and two at the front with location pins) and a fourth front central pillar (24) into which the fixing thumb screw (1) of the Quest ATR optical unit is tightened.

Fixing the Quest Optical Unit to the Benchmark™ Baseplate

The first step for installation is to fit the upper surface side of the Benchmark™ baseplate P/N 549-456 to the underside of the optical unit of the Quest ATR Accessory.

The rear support pillar (23) is a separate part from the main Benchmark™ baseplate assembly P/N 549-465. Passage of the slot head fixing screw (22) through the underside of the baseplate and the pillar (23) itself into the rear location hole on the underside of the optical unit secures the pillar (23) in place for support of the Quest ATR Accessory when in position. Therefore take the Quest ATR Accessory and place it correctly over the Benchmark™ baseplate to loosely secure the optical unit to the central front pillar (24) by tightening of the central front thumbscrew (1) of the optical unit. The thumbscrew (1) engages with the pillar (24) threading from pushing down on the thumbscrew (1) and beginning to turn it clockwise.

When the optical unit is more or less securely affixed via the front central thumbscrew (1) and pillar (24) fixing, take the rear support pillar (23) and carefully introduce it between the underside of the optical unit and the top surface of the Benchmark™ baseplate at its rear fixing/support position. Manipulate the rear support pillar (23) until its central screw hole aligns with its screw location hole on the underside of the baseplate and then introduce the slot head screw (22) through the baseplate and pillar (23) to emerge close to the threaded location hole recess in the underside of the optical unit. Use a slot headed screw driver to tighten the optical unit to the rear support pillar (23) and baseplate from clockwise rotation of the screw (22) until the screw is hand tight and all the fixing components are secure.

The front central thumbscrew (1) can now be fully hand tightened into the front pillar (24). When done, this completes the procedure for a secure attachment of the Quest ATR Accessory to the Benchmark™ baseplate P/N 549-456.

Fig 5. shows when the Quest ATR Accessory has been fitted correctly onto the Benchmark™ baseplate P/N 549-456.

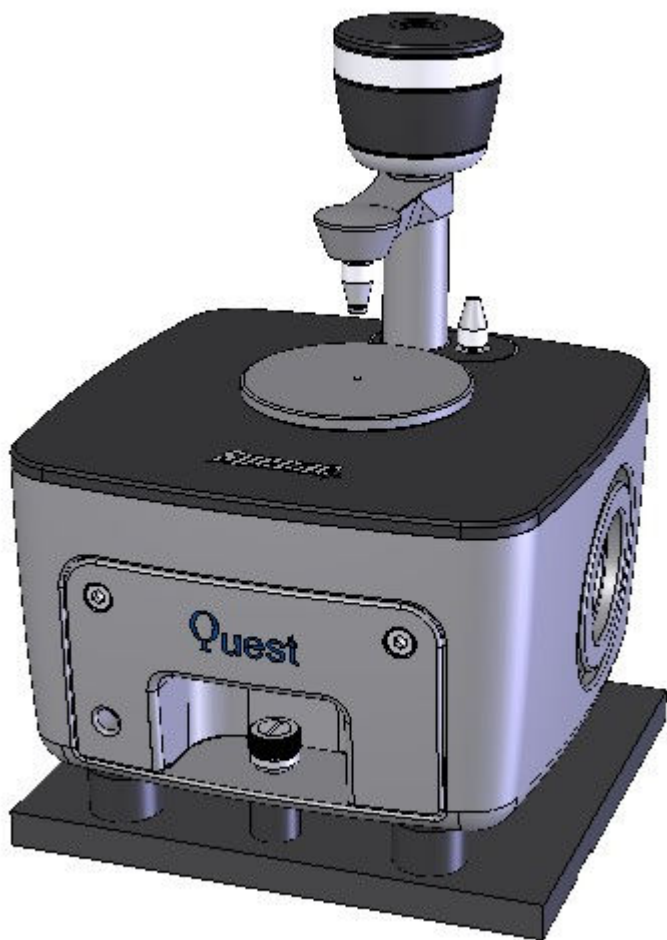

Fig 5. Fitting of the Quest ATR Accessory onto the Benchmark™ Baseplate P/N 549-456

Installing the Quest Optical Unit and Benchmark™ Baseplate Assembly into the Spectrometer Sample Compartment

When the optical unit of the Quest ATR Accessory has been securely fitted to the Benchmark™ baseplate P/N 549-456, the complete assembly of parts can be installed into the sample compartment of either a Shimadzu IR-Affinity or Tracer 100 IR spectrometer.

Note: *The cover plate P/N GS10854 should have already been fitted. (See Section 4 – pages 7 and 8.)*

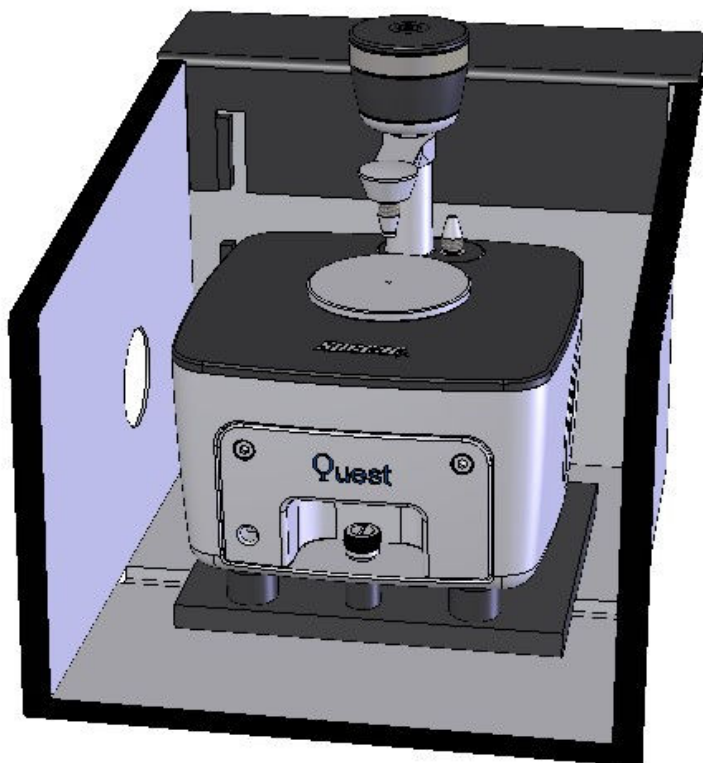

Fig 6. Installation of the Quest ATR Accessory on Benchmark™ Baseplate P/N 549-456 into the Sample Compartment

In reference to the underside surface of the Benchmark™ baseplate (see **Fig 3**), there is a location bar where the integrated circuit (IC) recognition chip contact point (**25**) is affixed. The complete assembly of Quest ATR Accessory on the Benchmark™ baseplate is carefully lowered into place within the sample compartment such that the location bar and IC chip contact point (**25**) engage centrally and towards the front of the sample compartment with the chip connection point in the grooved recess channel of the floor of the sample compartment. The whole Quest ATR Accessory on the Benchmark™ baseplate will sit flat and evenly level with the floor of the sample compartment when the location bar and chip contact point (**25**) components are properly engaged.

Caution! *The IC chip contact point of the location bar on the underside of the Benchmark™ baseplate is in a relatively exposed position, so be very careful when installing or removing the complete assembly of parts from the sample compartment to prevent any damage occurring.*

Fig 6. shows when the Quest ATR Accessory on the Benchmark baseplate has been correctly installed into the sample compartment.

Use of Shortened Purge Bellows P/N GS10855

The purge bellows P/N GS10855 that are shorter than the standard pair of purge bellows (P/N GS10707) normally supplied with the Quest ATR Accessory, can be used to fit neatly and exactly between the Quest optical unit aperture ports and the sample compartment inlet and outlet optical beam side ports for both the IR-Affinity and Tracer 100 instruments. Consult the User Instruction Manual 2I-10800-3 (pages 18 to 20) to advise on how the purge bellows P/N GS10855 are fitted to the optical unit **prior to** any installation of the Quest ATR Accessory already fitted to the Benchmark™ baseplate P/N 549-456, should a purge gas facility need to be established for any spectral data collection.

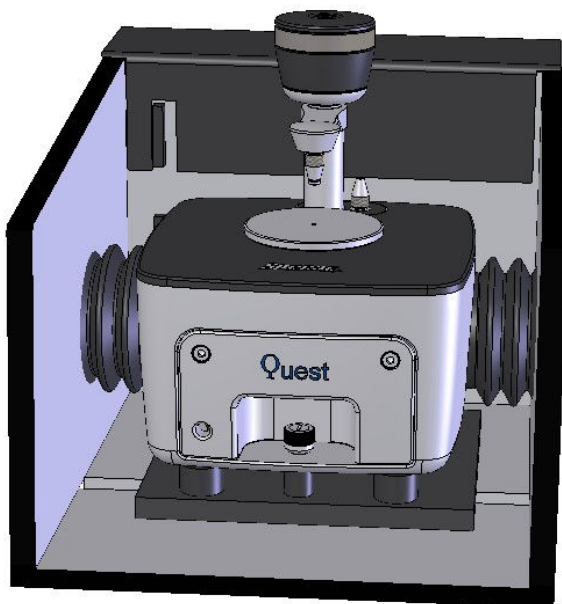

Fig 7. Installation of the Quest ATR Accessory into the Sample Compartment with Purge Bellows P/N 549-456

Fig 7. shows when the Quest ATR Accessory on the Benchmark™ baseplate P/N 549-456 has been correctly installed into the sample compartment with a fitting of the shortened purge bellows P/N GS10855.

Alignment Procedure

When the Smart Quest ATR Accessory has been installed from a **first fitting** into the sample compartment (with or without use of the shortened purge bellows P/N), the Smart Quest ATR Accessory will need to be fine-tuned for an optical alignment for the specific spectrometer system

Therefore, please follow the alignment procedure instructions as found in the Quest ATR Accessory User Instruction Manual 2I-10800-3 from page 8 and onwards.

6. Smart Quest ATR Accessory “Bubble Numbers” Part Identification List

- (1) Optical unit fixing thumb screw to Benchmark™ baseplate.
- (22) M3 x 25mm slot head fixing screw.
- (23) Rear support pillar on Benchmark™ baseplate.
- (24) Front central support pillar on Benchmark™ baseplate.
- (25) Location bar and IC recognition chip on Benchmark™ baseplate.

7. Smart Quest ATR Accessory Spare Parts

Complete Accessories – (Optical unit with clamp arm assembly, specific ATR crystal puck option and Benchmark™ baseplate)

GS10850-A - Quest ATR Diamond Accessory (Aqua).
GS10850-B - Quest ATR Diamond Accessory (Black).
GS10850-R - Quest ATR Diamond Accessory (Red).
GS10851-A - Quest ATR Diamond Accessory extended range (Aqua).
GS10851-B - Quest ATR Diamond Accessory extended range (Black).
GS10851-R - Quest ATR Diamond Accessory extended range (Red).
GS10852-A - Quest ATR ZnSe Accessory (Aqua).
GS10852-B - Quest ATR ZnSe Accessory (Black).
GS10852-R - Quest ATR ZnSe Accessory (Red).
GS10853-A - Quest ATR Germanium Accessory (Aqua).
GS10853-B - Quest ATR Germanium Accessory (Black).
GS10853-R - Quest ATR Germanium Accessory (Red).

Replacement Crystal Puck Assemblies

GS10810 Quest ATR Diamond Crystal Puck.
GS10811 Quest ATR Diamond Extended Range Crystal Puck.
GS10812 Quest ATR ZnSe Crystal Puck.
GS10813 Quest ATR Ge Crystal Puck.

Spare Parts

GS10820 Quest ATR Self Leveling Flat Anvil.
GS10821 Quest ATR Pellet Anvil.
GS10825 Quest ATR Volatiles Cover.
GS10854 Cover plate for Shimadzu IR-Affinity and Tracer 100.
GS10855 Shortened purge bellows (pair).

8. Smart Quest ATR Serial Numbers

Your Smart Quest ATR Accessory will be provided with a serial number for identification of certain individual part assemblies. To help you, please use the grid below to fill in the serial number information of the Quest ATR Accessory parts you have received. If you need to contact Specac for any issues regarding your Quest ATR Accessory it may be necessary to provide the serial number of the item to identify for replacement parts.

Smart Quest ATR Part Number and Description	Serial Number
GS10850-A - Quest ATR Diamond Accessory (Aqua)	
GS10850-B - Quest ATR Diamond Accessory (Black)	
GS10850-R - Quest ATR Diamond Accessory (Red)	
GS10851-A - Quest ATR Diamond Accessory extended range (Aqua)	
GS10851-B - Quest ATR Diamond Accessory extended range (Black)	
GS10851-R - Quest ATR Diamond Accessory extended range (Red)	
GS10852-A - Quest ATR ZnSe Accessory (Aqua)	
GS10852-B - Quest ATR ZnSe Accessory (Black)	
GS10852-R - Quest ATR ZnSe Accessory (Red)	
GS10853-A - Quest ATR Diamond Accessory (Aqua)	
GS10853-B - Quest ATR Diamond Accessory (Black)	
GS10853-R - Quest ATR Diamond Accessory (Red)	

Worldwide Distribution

France

Eurolabo - Paris.
Tel.01 42 08 01 28
Fax 01 42 08 13 65
email: contact@eurolabo.fr

Germany

L.O.T. - Oriel GmbH & Co,
KG - Darmstadt
Tel: 06151 88060
Fax: 06151 880689
email:info@LOT-Oriel.de
Website: www.LOT-Oriel.com/de

Japan

Systems Engineering Inc. -Tokyo
Tel: 03 3946 4993
Fax: 03 3946 4983
email:systems-eng@systems-eng.co.jp
Website: www.systems-eng.co.jp

Spain

Teknokroma S.Coop C. Ltda
Barcelona
Tel: 93 674 8800
Fax: 93 675 2405
email: comercial@teknokroma.es

Switzerland

Portmann InstrumentsAG
Biel-Benken
Tel: 061 726 6555
Fax: 061 726 6550
email: info@portmann-instruments.ch
Website:www.portmann-instruments.ch

USA

SPECAC INC.
414 Commerce Drive
Suite 175,
Fort Washington,
PA 19034, USA
Tel: 215 793 4044
Fax: 215 793 4011

United Kingdom

Specac Ltd. - London
River House, 97 Cray Avenue,
Orpington
Kent BR5 4HE
Tel: +44 (0) 1689 873134
Fax: +44 (0) 1689 878527
Registered No. 1008689 England

Brilliant Spectroscopy™

www.specac.com

SPECAC INC.

414 Commerce Drive
Suite 175,
Fort Washington,
PA 19034, USA
Tel: 215 793 4044
Fax: 215 793 4011

SPECAC LTD.

River House, 97 Cray Avenue,
Orpington
Kent BR5 4HE
Tel: +44 (0) 1689 873134
Fax: +44 (0) 1689 878527
Registered No. 1008689 England